



Hillrom is a part of Baxter

Baxter



Hillrom™

Safe Patient Handling & Mobility

Lifting Solutions

Distributed by Aidacare

SAFETY IN MOTION

At Hillrom, we believe mobility and safety should go hand in hand. In fact, it's our specialty. With more than 30 years' experience in safe patient handling, we design our lifting and transferring solutions to help caregivers like you get patients moving — earlier and often.

**Our mission is simple:
Protecting patients
by mobilising earlier
and often.**

Our comprehensive portfolio of lifts, slings and accessories supports this mission — and is backed by the power of the full Hillrom portfolio. It's what lets us offer you a complete early mobility program focused on reducing risk for both patients and caregivers.

Just like you.

SLINGS

MOBILE LIFTS

SIT-TO-STAND LIFTS

OVERHEAD LIFTS

BARIATRIC SOLUTIONS

HORIZONTAL LIFTING

MANUAL TRANSFER AIDS

ACCESSORIES

SUPPORT

THE SLING IS HALF THE LIFT

A comfortable, effective lift starts with the right sling. And to choose the right sling, we must understand both the patient and the environment at hand.

Our global reach and long history means we intimately understand the needs of patients and caregivers — and we've designed our full line of slings with those needs in mind.



1. Horizontal lifting
Severely injured people often need to be lifted in a horizontal position. We offer several lift stretchers designed for settings like intensive care and surgery, supporting patients with back injuries and burns. We also offer accessories for transfers from emergency and ambulance gurneys.



2. Repositioning
Repositioning patients involves lifting — and, too often, this leads to work-related injuries. That's why we offer positioning aids to help make this common task safer and easier.

3. Bed to chair
Transferring to bedside chairs is a common need, so we focus on making it comfortable and safe.

4. To/from the toilet
Lifting someone to and from the toilet, while dressing and undressing them, requires a specialised solution. Our slings provide the access around the body you need — without compromising safety.

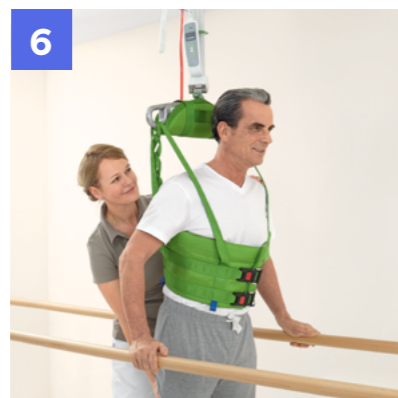
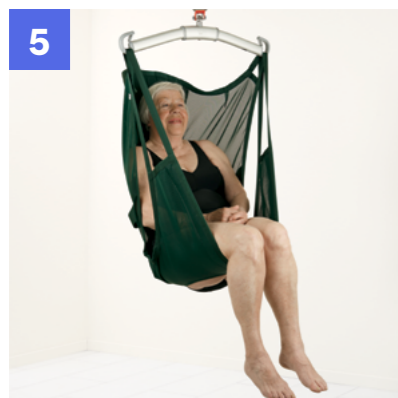

5. To/from the pool
Our sling, made from plastic-coated net, safely moves the patient in a sitting position.

6. Ambulation
Mobilisation is both physically and psychologically important for patient well-being. Our accessories for standing and gait training give patients the freedom to stand and move under safe, controlled conditions.



7. To/from the floor
Whether a patient has fallen or is in rehabilitation, lifts from the floor should be gentle. Our lifts and slings support the entire body to make the process comfortable for both patients and caregivers.

8. Static hold
Lifting and holding a patient's arm or leg can be a heavy task. We designed our MultiStraps to ease your burden.

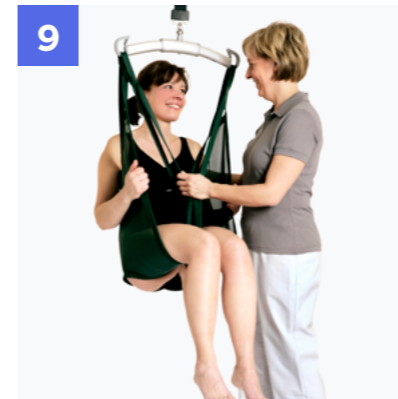

9. Bath and shower
These slings are made from a permeable, plastic-coated net. And we offer a variety of models to provide comfort and support for a variety of patient needs.

PATIENT TYPES

10. Leg amputees
We offer several slings for leg amputees. Choose the right model for each patient, based on the degree of amputation and the care task at hand.

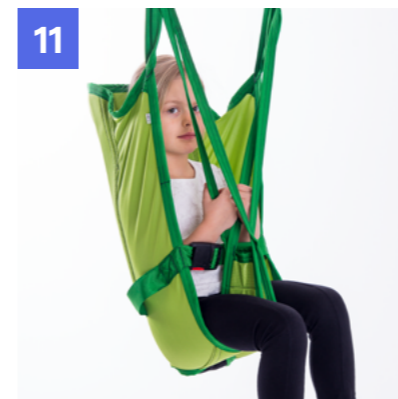

11. Children
Children are not small adults. We have a long history designing lifts for some of your littlest patients.

12. Patients of size/bariatric patients
Mobilising patients of size requires specialised equipment and specialised technique. We offer solutions to help you lift and reposition patients weighing up to 500 kg.



GENERAL

13. Pain/pressure sensitive
Soft-padded slings contribute to the distribution of pressure for the mobilisation of pain-sensitive patients.

14. Single-patient use (SPU)
To reduce the risk of spreading infections, disposable slings, sheets, and lift aids are offered for repeat use with a single patient.

LEARN MORE ABOUT SLINGS

* Infection Control Today, Disposable Products Enhance Infection Prevention Efforts. <https://www.infectioncontroltoday.com/personal-protective-equipment/disposable-products-enhance-infection-prevention-efforts>. Accessed April 29, 2020.



MOBILE LIFTS— WHEN AND WHERE YOU NEED THEM

Do budget or technical considerations make an overhead system unrealistic? Do you need to pick up patients who have fallen beyond the reach of an overhead lift?

In these cases, and in countless others, a mobile lift can provide the safety and support you need.

Golvo® Mobile Lift

The Golvo lift combines the versatility of a mobile lift with the functionality of an overhead lift.

With its unique design and flexible lift strap, it supports many types of applications. Its retractable armrests are well suited for gait training during rehabilitation. And its efficient design and recyclable aluminum make it both lightweight and strong — a powerful combination.

LEARN MORE ABOUT
MOBILE LIFTS

Taking the Functionality of Overhead Lifting Mobile

- Vertical lifting motion with flexible lift strap is ideal for horizontal lifting, walking and lifting from the floor.
- Adjustable-width base supports easier transfers to/from chairs, beds and the floor.
- LowBase version provides even greater clearance under low beds or stretchers compared to the standard model.
- Retractable armrests support patients while they walk.
- User display highlights device usage (e.g., lift count, service required indicator and overloads).
- Optional quick-release hook system helps caregivers easily change a slingbar or install a scale.
- Ergonomic hand control displays battery usage and overload indicators.



Safe Working Load: 200 kg
Models: Golvo® Mobile Lifts 9000 | 9000 LowBase



The Golvo lift design makes it especially suitable for horizontal lifting



Flexible lift strap adapts the lift to the patient

Viking® Mobile Lifts

Safe patient handling calls for a patient-centered approach. With the Viking lifts, you can choose just the right lift for each patient, and rest assured you'll receive the consistent, high-quality experience you expect.



Viking XL Mobile Lift

A strong choice for patients of size, the Viking XL is also suitable for average-weight people.

Weight: 37 kg
Safe working load: 300 kg



Viking M Mobile Lift

The all-around Viking M is designed for your most common lifting needs.

Weight: 30 kg
Safe working load: 205 kg



Viking L Mobile Lift

This easy-to-handle lift is designed for heavy lifting, as well as common needs.

Weight: 37 kg
Safe working load: 250 kg



Flexible Choices with Consistent Quality

- User display highlights device usage (e.g., lift count, service required indicator and overloads).
- Optional quick-release hook system helps caregivers easily change a slingbar or install a scale.
- Optional armrests support patients while they walk.
- A wide variety of accessories like slings, slingbars and scales help you adapt the lift for different needs.



The open undercarriage and many assistive devices support lifting to and from the floor



The Viking series supports a wide variety of patient care tasks, including wound care



The lifts are easy to manoeuvre, even in confined spaces



SIT-TO-STAND LIFTS

When patients need help standing, we help them rise to the occasion. Our solutions can help compensate for poor balance to get them stable — and contribute to active training to get them stronger.

Sabina® II Sit-to-Stand Lift

For patients who can actively participate in raising and standing, the Sabina® II lift is an easy-to-use and versatile solution. The lift uses a sit-to-stand vest to support the patient's upper body — and several types of vest are available depending on the need.

When a patient is standing, transfers are easier and smoother — for example, from a wheelchair to the toilet. Better yet, the transfer itself can provide valuable standing training.

LEARN MORE ABOUT SIT-TO-STAND LIFTS

Providing Support and Stability

- Adjustable-width base offers flexibility when transferring from a bed or chair.
- Adjustable height settings accommodate patients of many sizes.
- A wide range of accessories — including slingbars, heel support and seat straps — help adapt the device for each patient
- Lower leg support and footrest are easy to remove for cleaning.
- Wider Comfort Slingbar helps adapt the device for patients who are especially sensitive to pain, or paralysed on one side.
- Can be used for sitting lifts with a universal sling — e.g., when the patient is not quite strong enough to rise to a standing position actively.

Safe Working Load: 160-200 kg, depending on the application



OVERHEAD LIFT SYSTEMS

Since no two patients are alike, patient-rooms are designed with flexibility. The same is true for our overhead lift systems — which are always at hand to help you mobilise patients safely and easily.

We offer a variety of components to address different patient mobility needs, care protocols and facility requirements. Our lift systems are designed for the many care environments you support —and all are focused on the highest levels of function, safety and availability.



Intensive Care

Where are overhead lifts used?

- Intensive care unit
- Medical/surgical
- Bariatric
- Emergency department
- Recovery
- PACU
- Long Term Care
- Neurology
- Rehabilitation/physical therapy
- Operating room
- Pre/post anesthesia care
- Imaging
- Morgue
- Home care
- Pool



Long Term Care
Traverse System with resident access into bathroom with turntable

LikoGuard® Overhead Lift

Our latest overhead lifting innovation raises the bar on safety and performance. This single-motor lift has undergone extensive testing for durability and reliability — so it's ready to perform in today's demanding healthcare environments. And its unique SlingGuard™ slingbar helps ensure the sling is properly attached, giving you confidence in your patient's safety.

Refer to your Hillrom representative for specific models available in Australia

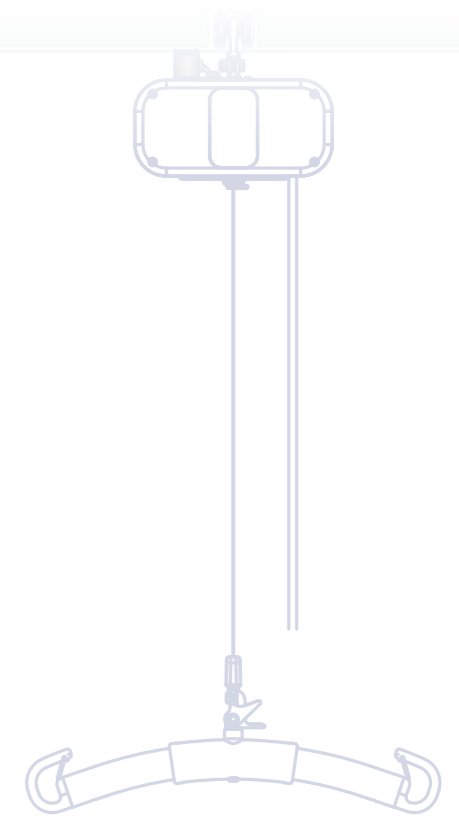

LEARN MORE ABOUT OVERHEAD LIFT SYSTEMS



Designed with Your Demanding Healthcare Environment in Mind

- Lightweight, environmentally friendly lithium-ion battery provides reliability and durability with its low self-drainage and deep discharge protection.
- Manual emergency stop and lowering mechanisms are easy to reach, engage and operate — no tools, ladder or force required.
- Innovative SlingGuard slingbar helps ensure slings attach correctly to keep patients safer
- Two options for hand controls (IPX7 rated) — with adjustable cable lengths—display service, overload and battery indicators.
- Optional in-rail charging ensures the lift is always ready to use.

Safe Working Load: L: 272 kg / XL: 363 kg



Likorall® Overhead Lift

User-friendly operation. Strong focus on safety. Thoughtful design. The Liko is known for all these and more, making this overhead lift system a good fit for a variety of healthcare settings.

- Mechanical or electrical emergency lowering available.
- Patented safety drum adds extra security and ensures even, controlled lowering.
- Safety Squeeze Protection Limit Switch protects the lift motor from mechanical strain and helps prevent injuries to patients and caregivers.
- Room-to-room (R2R) model helps you efficiently move patients between rooms without a continuous rail connection.
- On the ES model, the hand control can help you navigate through switches and turn tables.
- UltraTwin ceiling mounted lift system consists of two Liko lift motors that provide a combined lifting capacity.



Safe Working Load

Standard models:
200 – 250 kg, depending on model

Dual motor combinations:
400 – 500 kg, depending on model

Room-to-room model:
200 kg

Available Models

Likorall™ Overhead Lift Systems
200 | 242 S, S R2R, ES, ES R2R |
250 ES, S IRC

1. Moving the Lift Motor

The Quick-Release Hook™ Carriage makes it easy to move the system between rooms.

2. In-Rail Charging (Likorall 250 S IRC)

The lift unit is constantly charged along the complete rail system, so it's always ready for use.

3. Easy to Charge

The Liko lift can also be charged by placing the hand control in a wall-mounted charger or parking the motor under a multistation.

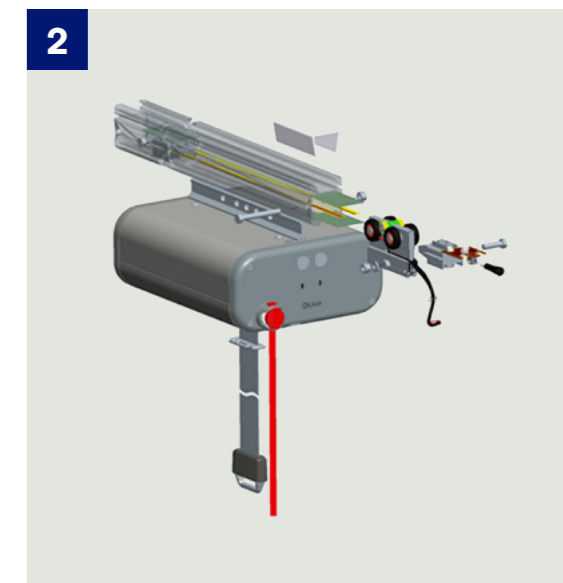

Multirall™ 200 Lift

When lifting needs are temporary (depending on your patient's mobility), the Multirall portable overhead lift can be a good alternative to a mobile lift.

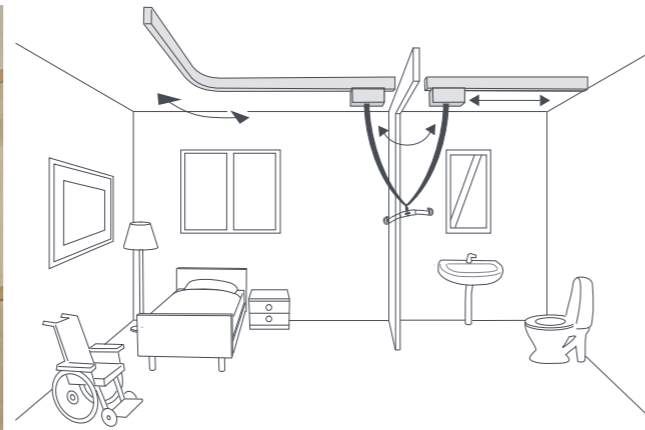

Room-to-Room
With a room-to-room strap, transfers can be made with just one lift motor.

Multirall Trolley
Ideal for moving, installing and storing the Multirall lift and accessories.

Portable and Flexible

- Two ways to mount:
 - + Motor High
Strap below the lift motor for more stationary use.
 - + Motor Low
Strap above the lift motor for more mobile use.
- Can be used with all Liko rail systems, including the FreeSpan system.
- Easy-to-move with the optional Extension Arm Adapter — no tools needed.
- Large handles on both sides of the motor make it easy to transport.
- The Qlink2 offers a safe, simple interface between the Multirall and the S65 Carriage Hook Multirall/Likorall, regardless of which way it is mounted.



With its Extension Arm and Quick-Release system, it's easy to attach and remove from the ceiling rail, helping you move the system between rooms—no tools required.

And when you need to move patients between rooms without connected rail systems, it uses just one lift motor to transfer the patient sitting in the sling.



BARIATRIC PATIENTS HAVE SPECIAL NEEDS.

Mobilising patients of size takes more than the ability to handle a heavier load. It requires specially designed accessories to help make the process safe, efficient and dignified.

UltraTwist™ System

Available in straight rail or traverse models, the system consists of two Likorall motors which, together, offer a lifting capacity of up to 500 kg. With the UltraTwist accessory, you can adjust the patient's position during and after the transfer.

UltraTwist accessory (displayed at left).

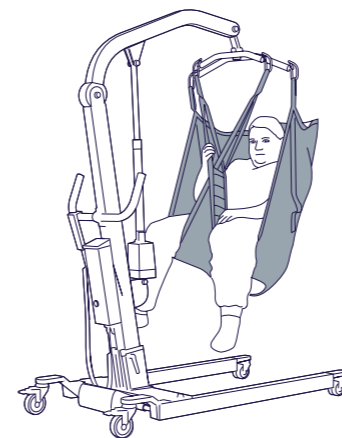
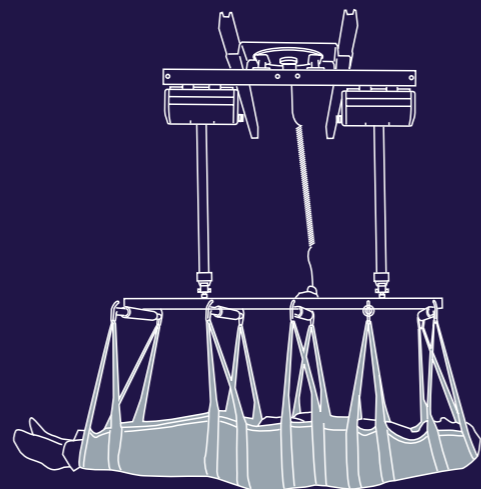

1. Viking® L/XL Mobile Lifts

Part of the versatile Viking series, the L and XL models are well suited for bariatric patients. Able to lift up to 250 kg and 300 kg respectively, their aluminum design makes them easy to manoeuvre.

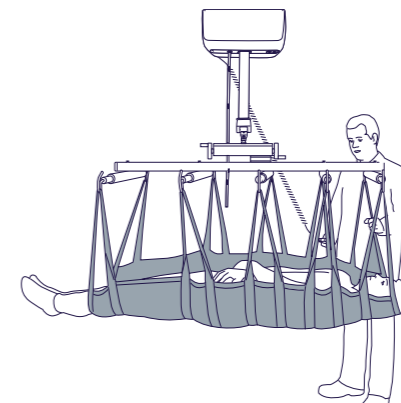

2. Overhead Lifts

Our latest innovation in single-motor overhead lifts raises the bar on safety and performance. It supports up to 363 kg depending on model, and features an emergency stop and lowering mechanism. Plus, the SlingGuard slingbar helps ensure the sling is properly attached, so you're confident your patient is safe while moving.



3. Liko UltraSling™ accessory

We designed our UltraSling for seated lifts/transfers for the heaviest patients – up to 500 kg. Its separate leg sections connect to a secondary slingbar, and it is used with our UltraTwin system via permanent installation or the FreeSpan free-standing system.

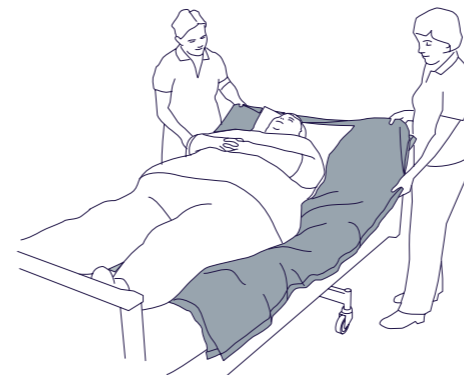

4. RepoSheet® Ultra Positioning Aid

To help prevent pressure injuries in heavy patients, turning and positioning are important¹ – but often challenging. We designed this aid to help, with a safe working load of up to 500 kg. It can be used with a range of Liko bariatric lifting solutions.

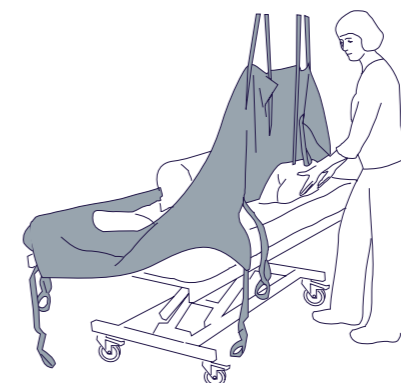

5. HandySheet™ Positioning Aid

Placing a sling under patients of size can be difficult. The HandySheet helps make it easier – and it can also be used for transfers in the bed.

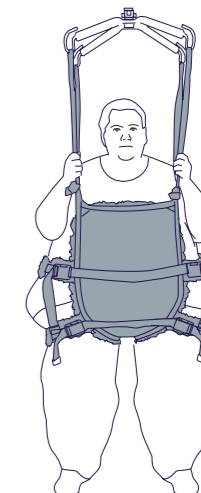

6. Ambulation with ULTRA LiftPant™ Accessory

Early mobilisation allows patients to maintain and improve mobility status. Supporting up to 500 kg, Ultra LiftPants support the whole body, giving patients the confidence they need to take those first steps.

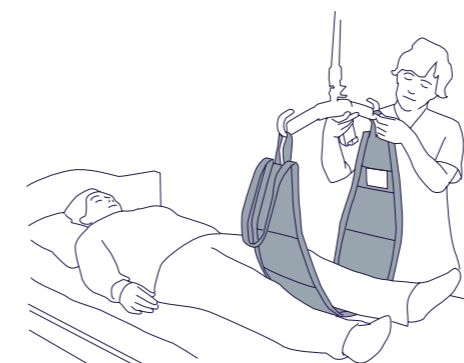

7. MultiStrap™ Lifting Accessory

The MultiStrap is designed to make it easier to hold the arm, leg or other body part of a patient of size. It can also be used to turn a patient in bed and support prone positioning.

¹ Chapter 8: Repositioning and Early Mobilization. In: Prevention and Treatment of Pressure Ulcers/Injuries: Clinical Practice Guideline, The International Guideline 2019. European Pressure Ulcer Advisory Panel, National Pressure Injury Advisory Panel and Pan Pacific Pressure Injury Alliance.

HORIZONTAL LIFTING IN HOSPITALS

In the hospital, and especially in the ICU, severely injured patients often need to be moved in a completely horizontal position — to and from operating tables, x-ray equipment, beds and stretchers. So we've collaborated with intensive-care specialists to design a range of horizontal lifting solutions that support safe movement while minimising impact on patients.

OctoStretch™ Lift Stretcher

The OctoStretch accessory is well suited for surgical, radiology and ICU departments. It can be used with all Liko overhead lifts, as well as a selection of mobile lifts.

Safe working load: 200 kg

UltraStretch™ Lift Stretcher

Our strongest horizontal lift accessory, the UltraStretch is used with the overhead UltraTwin system, which consists of two interconnected Likorall motors. Therefore, the stretcher also has two fixture points which must always be used together.

Safe working load: 400 kg

FlexoStretch™ Lift Stretcher

This lift stretcher accessory is especially appropriate for heavier patients. Its width is adjustable from 70 – 95 cm and the Stretch Leveler easily controls the patient's horizontal position.

Safe working load: 300 kg

FlexoStretch Lift Stretcher shown with stretch leveler.

LikoStretch 600 IC™ Lift Stretcher

This horizontal lift accessory is designed for your most sensitive patient handling needs—for example, patients with burns or back injuries who cannot be turned to their sides. The straps can be placed gently under the patient, minimising contact with the skin. They can then be arranged to avoid pressure on wounds or injured areas.

Safe working load: 200-250 kg, depending on design



MANUAL TRANSFER AIDS

For transfers and in-bed mobility

HandySheet™ and HandyTube™ Positioning Aids

When you're applying a sling, the HandySheet™ manual transfer aid reduces friction between the patient and underlying surfaces. It is ideal for patients of size, pain-sensitive patients and patients with contractures.

The HandyTube™ manual transfer aid is a sliding sheet to assist with short transfers in bed, between two beds or from bed to stretcher.

In-Bed Mobility

- High-quality fabric ensures good sliding capacity, even after repeated washes.
- Friction-reducing properties aid in-bed mobility to build patient strength during in-bed squats or passive range of motion exercises.



LIFTING ACCESSORIES

We offer a variety of 2-point and 4-point sling bars, scales, disposables, and accessories to meet your everyday needs.



SUPPORTING YOU EVERY STEP OF THE WAY

At Hillrom, we're more than a lift manufacturer. We're your full-service partner — from planning to implementation and beyond.

Safe Transfers and Movement™ Program (STAMP)

When smart solutions are backed by clinical evidence, better outcomes are possible. That's why we help providers like you implement evidence-based clinical programs focused on early mobility, falls prevention, skin safety and more.

With our Safe Transfers and Movement Program, our clinical experts will help you develop and implement a safe patient handling and mobility program, and we'll back it up with any support and training you may need along the way.

Building a Smarter Future with Hillrom Construction Solutions

The Hillrom Construction Portal is a powerful tool for architects and healthcare facility designers. The resource centre includes:

- Free, downloadable room layouts and DWG blocks.
- Design specifications.
- Videos, images and more.

[LEARN MORE ABOUT CONSTRUCTION SOLUTIONS](#)

Bedside Mobility Assessment Tool (BMAT) 2.0

The Bedside Mobility Assessment Tool (BMAT) 2.0 is a validated tool to help nurses assess mobility at the bedside. At Hillrom, we offer CE programs, tools and assessment training aligned with the BMAT 2.0 principles and clinical application.

The goal? Helping you get your patients moving earlier and often — in the safest possible way. Talk to your Hillrom representative to learn more.

[LEARN MORE ABOUT BMAT](#)





Hillrom™

Distributed by



1300 133 120 | aidacare.com.au

For further information about our products or services, please contact your local Aidacare representative or call our customer services team on **1300 133 120**.

Always read the labels and instructions for use. Please contact your Aidacare representative for the latest version.

REFER TO YOUR AIDACARE REPRESENTATIVE FOR SPECIFIC MODELS AVAILABLE IN AUSTRALIA

Hillrom range of lifts and accessories are intended to be used for the lifting and transferring of patients in a variety of care settings. Hillrom slings and accessories are intended to be used in combination with Hillrom lifts for a range of lifting and transferring situations in a variety of care settings.

Class 1

Manufacturer: Liko AB, Nedre vägen 100, 975 92 Luleå, Sweden

These products are regulated health care products which, where required by applicable regulations, bear a CE mark. Hill-Rom recommends you carefully read the detailed instructions for safe and proper use included in the documentation accompanying medical devices. The personnel of healthcare establishments are responsible for the proper use and maintenance of these medical devices.

Hill-Rom reserves the right to make changes without notice in design, specifications and models. The only warranty Hill-Rom makes is the express written warranty extended on the sale or rental of its products.

© 2022 Hill-Rom Services, Inc. ALL RIGHTS RESERVED. APR310301-AU-r1 01-JAN-2022 ENG – ANZ/AU